



15 East Avenue Athens, TN 37303

(800) 521-2855

bullbbq.com

Single Slide-In Pro Side Burner

Owner's Manual

SKU# 60018 LIQUID PROPANE (LP)

SKU# 60019 NATURAL GAS (NG)



**USA
EDITION**



Important Safety Warnings

This appliance is FOR OUTDOOR USE ONLY. This appliance must not be used in a building, garage, or any other enclosed area.

WARNING: This appliance is not intended to be installed in or on a boat or recreational vehicle.

WARNING: Ensure that your side burner is properly installed, assembled, and maintained. Failure to adhere to these accompanying instructions may result in fire or explosion, causing serious bodily injury or death, and/or property damage.

DANGER

If you smell gas:

- **Shut off gas to the appliance.**
- **Extinguish any open flame.**
- **Open Lid.**
- **If odor continues, keep away from the appliance and immediately call your gas supplier or your fire department.**

WARNING

- **Do not store or use gasoline or other flammable liquids or vapors in the vicinity of this or any other appliance.**
- **An LP cylinder not connected for use shall not be stored in the vicinity of this or any other appliance.**

 **WARNING:** This product may expose you to chemicals including lead which is known to the State of California to cause birth defects or other reproductive harm.
For more information, visit: www.P65Warnings.ca.gov

IMPORTANT: Installation of this appliance must conform to local codes. In the absence of local codes, installation must conform to one of the following:

- ANSI Z223.1/NFPA 54
- CSA B149.1
- CSA B149.2

We care about your safety, so please...

Read and follow all warnings and instructions before assembling and cooking with your side burner.

Retain this manual for future reference.



Table of Contents

<i>Side burner Operational Safety</i>	4
<i>Liquid Propane (LP) Safety Guidelines</i>	5
<i>Liquid Propane (LP) Gas Requirements</i>	6
<i>Natural Gas (NG) Requirements</i>	7
<i>Checking for Gas Leaks</i>	8
<i>Determining the Location of the Side burner</i>	9
<i>Side burner Enclosure Requirements</i>	10
<i>Lighting the Side burner</i>	12
<i>Burner Flames</i>	13
<i>Burner Maintenance</i>	14
<i>Cleaning the Side burner</i>	16
<i>Troubleshooting</i>	17
<i>Product Warranty and Registration</i>	18
<i>Replacement Parts List</i>	19
<i>Warranty Policy</i>	20

Service Information

Model Number:

60018 (LP)

60019 (NG)

Serial Number: _____

Date of Purchase: _____

Place of Purchase: _____

Fuel Type:

Liquid Propane (LP)

Natural Gas (NG)

Side burner Operational Safety



WARNING: During use, and for some time afterwards, the side burner will become and stay hot enough to cause serious burns. Do not leave children or pets unattended within the vicinity of the side burner until it is no longer in use and has cooled completely. Never allow children to sit, stand, or play on or around the side burner.

- Never allow children to operate the side burner.
- Never lean over cooking surface while lighting side burner.
- Never place objects or utensils on top of side burner lid.
- Use barbecue tools with insulated handles and dry, good quality insulated oven mitts when operating the side burner. Wet or damp mitts/gloves/pot holders may cause steam burns.
- Allow side burner to cool completely prior to transporting or covering your side burner for storage.
- Do not place side burner under or on top of any surface that will burn.
- Do not allow obstructions or restriction of the flow of combustion and ventilation air around the side burner housing.
- Do not build the side burner into any combustible structure that is closer than 21 inches from the sides and back.
- Keep the vent openings of the cylinder enclosure, if applicable, free and clear from debris. Clean your side burner only with the recommended cleaning agents.
- Keep any electrical supply cord and the fuel supply hose away from any heated surfaces.
- Keep the area encompassing your side burner free and clear from any combustible materials, gasoline, and other flammable vapours and liquids.
- Do not operate this side burner in temperatures below 0°F (-17°C).

Gas Conversion Kits:

Gas valves are preset at the Bull factory to operate on either LP gas or Natural Gas. If you wish to convert to a different gas type aside from LP or Natural Gas, be sure to contact your side burner dealer, licensed plumber, or authorized service center for further details. Conversion kits will only be sold to professionals to perform conversion service. Failure to properly convert a unit can cause severe injury to yourself and/or others, irreparable damage to your side burner and void your warranty.



INSECT ALERT: Spiders and small insects occasionally spin webs or make nests inside the burners during warehousing, transit, and/or after long periods of non-use. These webs or nests can create a hazardous situation where gas flow is redirected and cause a fire type known as "FLASH BACK". This type of fire can cause serious damage to your side burner and create an unsafe operating condition. Frequent inspections and care are recommended and detailed further on page 14.



Liquid Propane (LP) Safety Guidelines

⚠️ DANGER:

- Do not store a spare LP gas cylinder under or near this appliance.
- Never fill the cylinder beyond 80% full.
- If the information above is not followed exactly, a fire causing death or serious injury could occur.

To avoid risk of fire or explosion, please take these safety precautions:

- Never connect an unregulated LP gas cylinder to the side burner.
- Do not subject LP gas cylinder to excessive heat.
- The LP gas cylinder must be constructed and marked in accordance with the *Specifications for LP gas Cylinders* of the U.S. Department of Transportation (DOT), or the standard for Cylinders, Spheres and Tubes for the Transportation of Dangerous Goods CAN/ CAS-B339.
- The LP gas cylinder must be provided with a listed overfilling prevention device.
- The LP gas cylinder must be provided with a cylinder connection device compatible with the connection for outdoor cooking appliances.
- Never use an LP gas cylinder that is visibly damaged, dented, or rusty.
- The LP gas cylinder must include a collar to protect the cylinder valve from damage.
- Ensure the LP gas cylinder has appropriate vapor withdrawal.
- Avoid unnecessary twisting of the hose.
- Prior to each use, visually inspect the LP hose for cuts, cracks, excessive wear or damage.
- The supplied pressure regulator and hose assembly (Bull part# 16589) must be used. Replacement pressure regulator and hose assemblies must be the type specified by Bull Outdoor Products.

When the appliance is not in use:

- The gas shall be turned off at the supply cylinder.
- The side burner may be stored indoors if and only if the cylinder is disconnected and removed from the side burner.
- The LP cylinders shall be stored outdoors out of reach of children and shall not be stored in a building, garage, or any other enclosed area.

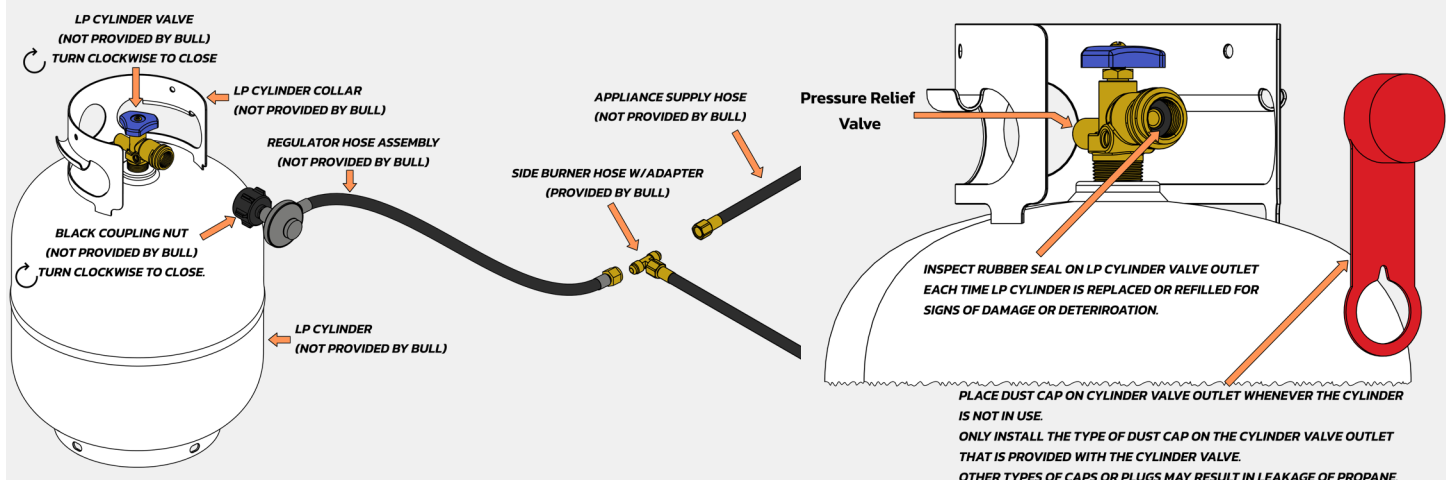

Liquid Propane (LP) Gas Requirements

Your propane gas side burner (SKU# 60018) is designed to operate on propane gas only. Each side burner is shipped with an LP supply hose that tees into an existing appliance supply. This connection must be made past the regulator outlet.

Connection to the Side burner:

The LP regulator hose assembly (not supplied with side burner) connects to the side burner through a provided 3/8" flare tee adapter*.

*3/8" refers to the tube outside diameter, *not* thread size.

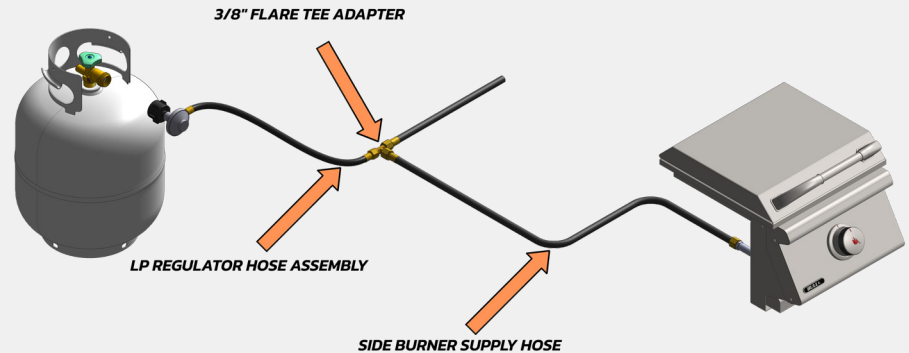

Cylinder Size: This side burner was designed for use with a standard 20lb (5 gallon) LP gas tank with a Type 1 connection.

Inlet Pressure: The provided LP regulator hose assembly maintains an 11" W.C. pressure at the inlet.

Cylinder Retention: Integral retention of the LP gas cylinder is required to limit movement of the cylinder. Bull offers many options to satisfy this requirement.

- For built-in applications, SKU# 16674 can be utilized and is shown below.
- Never mount the cylinder in an orientation such that the pressure relief valve is pointed towards the normal operating position of the user.

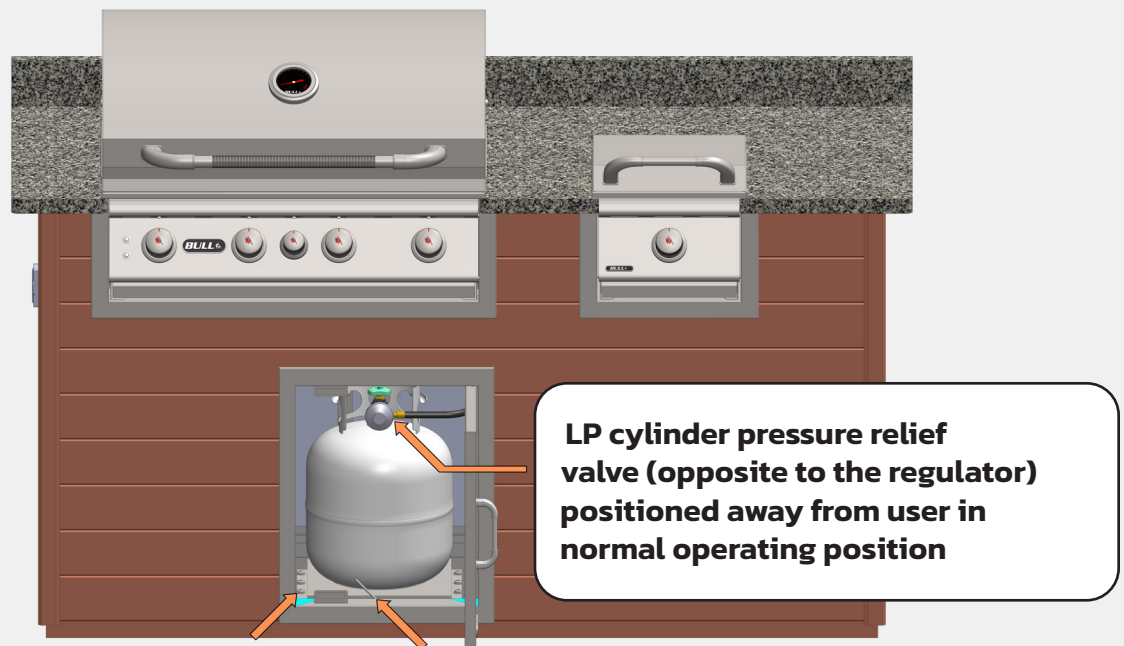

Bull 16674 LP gas cylinder retention system secured to enclosure with:

- 8x Screws
- 8x Washers
- 8x Locknuts

Bull 16674 LP gas cylinder retention bolt.

To secure cylinder:

- Turn clockwise

To remove cylinder:

- Turn counterclockwise

Natural Gas (NG) Requirements

Your natural gas side burner (SKU# 60019) is designed to operate on natural gas only. The side burner is not shipped with a regulator or hose(s) necessary to connect to an existing supply line.

Connection to the Side burner: Your side burner is equipped with a 3/8" male flare fitting. As individual installations may vary, it is the responsibility of the installer to ensure the side burner is properly connected to a natural gas system. A typical configuration is shown below, but is not intended to be all encompassing.

- An installer-supplied hose must be connected to an installer-supplied safety shut-off valve located and installed per local codes, or if in areas bereft of local codes, in accordance with ANSI Z223.1/NFPA 54 or CSA B149.1.
- All installer-supplied components for connecting the side burner to a fixed fuel piping system such as rigid pipe, semi-rigid tubing, and/or connectors must comply with ANSI Z21.75 • CSA 6.27.
- Do not use Teflon® tape or pipe sealant on any flare ends. Doing so will not allow for a leak-free seal.
- Only use pipe sealing compound or pipe thread tape of the type resistant to the action of natural gas to at least the first three threads of all male pipe threads when making the connection.

*3/8" refers to the tube outside diameter, *not* thread size.

Inlet Pressure: The installer-supplied NG regulator must maintain an 4" W.C. pressure at the outlet. If purchased from Bull, all stand-alone grills are shipped with the required regulator that can be used to supply both the grill and side burner.

Pressure Testing: When pressure testing is performed:

- This side burner, along with its individual shut-off valve, must be disconnected from the gas supply piping during any pressure testing of that system at test pressures in excess of 1/2 psi (3.5 kPa)
- This side burner must be isolated from the gas supply piping system by closing its individual shut-off valve during any pressure testing of the gas supply piping system at test pressures equal to or less than 1/2 psi (3.5 kPa).

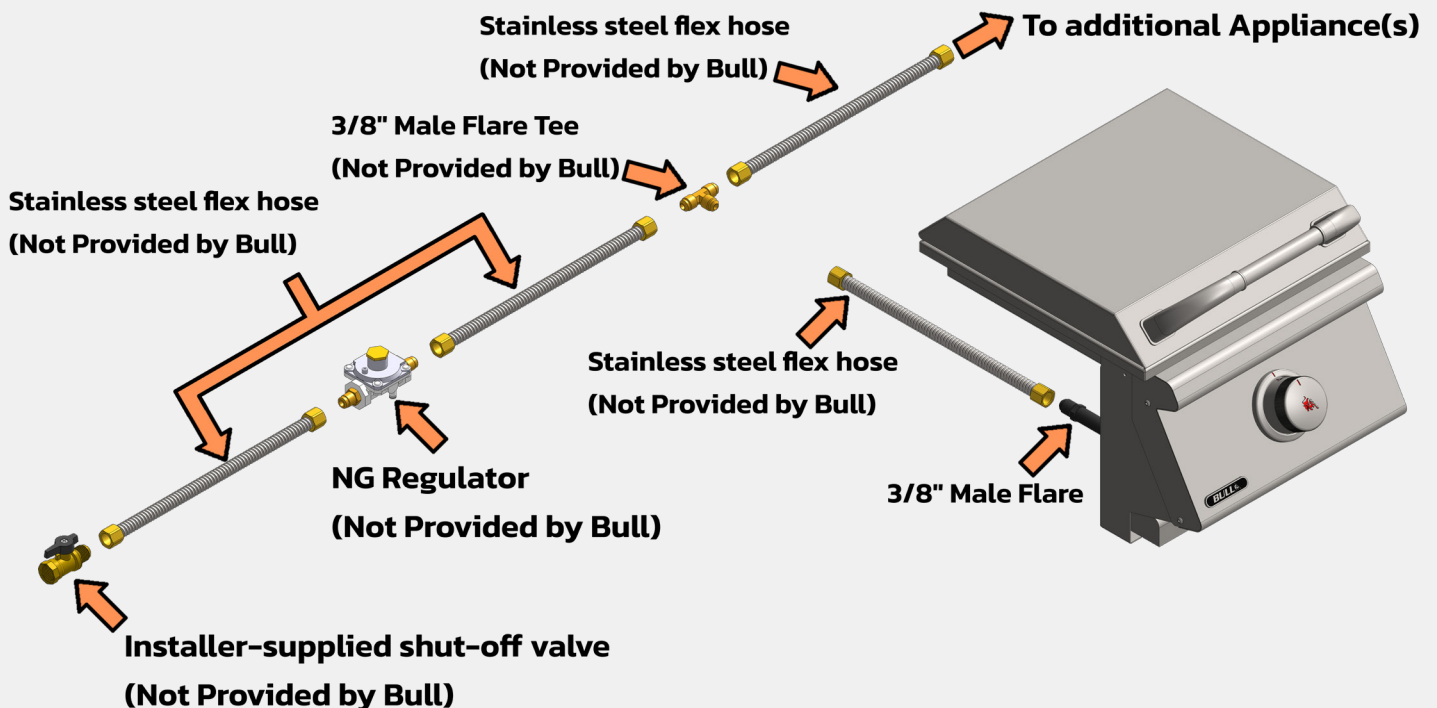

Checking for Gas Leaks

When should I test for leaks?

A comprehensive leak test should be performed:

- After initial installation of the side burner is complete, and before first using the side burner.
- Periodically before (and throughout) the start of a new season.
- For LP model side burners, check each time an LP gas cylinder is connected to the side burner.
- If you smell gas... however, recall the warning below! Turn off the gas to the side burner, and ensure the odor does not linger before continuing with the leak test.

⚠ DANGER

If you smell gas:

- **Shut off gas to the appliance.**
- **Extinguish any open flame.**
- **Open Lid.**
- **If odor continues, keep away from the appliance and immediately call your gas supplier or your fire department.**

How do I perform a leak test?

- It is recommended to use a leak detection compound conforming to MIL-L-25567D. Alternatively, mix a 1:1 solution of liquid detergent and water into a spray bottle.
◊ *Never use an open flame to test for leaks.*
- Ensure all heat control valves are turned off and then turn on the gas supply.
- Apply the leak detection solution to all components of the gas delivery system, which consists of valves, connectors, piping, and hoses, at every point from the gas supply to the burners.
- Visual indicators of a failed test are any blowing bubbles present in the leak detection solution.
- Olfactory indicators of a failed test are any faint sulfurous smells present similar to that of rotten eggs.

IMPORTANT: Rectify any leaks immediately and do not use the side burner until all connections have been checked and are leak-free.

LP Leak Test Detail

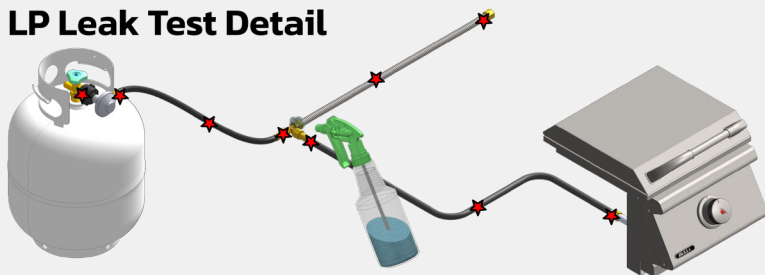

NG Leak Test Detail

Bubbles indicate leak

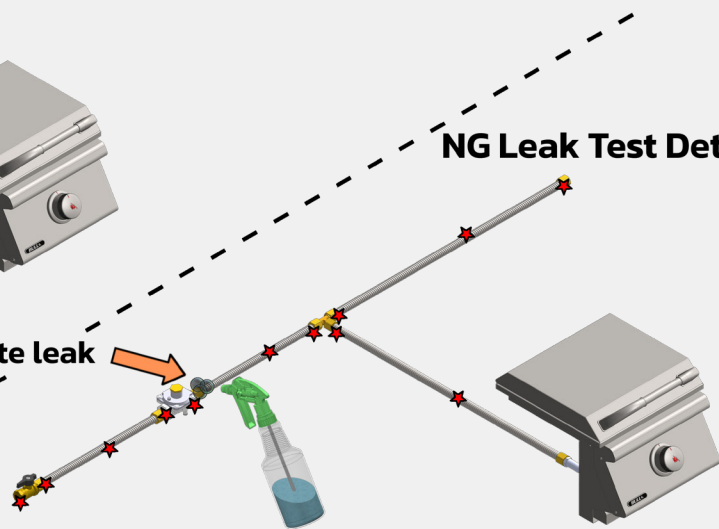

★ Apply Solution at locations indicated by this symbol p. 8

Determining the Location of the Side burner

This side burner is for outdoor use only. An appliance is considered to be outdoors if:

- Installed with shelter no more inclusive than with walls on three sides, but with no overhead cover; all openings must be permanently open; sliding doors, garage doors, windows, or screened openings are not considered as permanent openings. **OR**
- Installed with shelter no more inclusive than within a partial enclosure that includes an overhead cover and no more than two sidewalls. The sidewalls may be parallel, as in a breezeway, or at right angles to each other; all openings must be permanently open; sliding doors, garage doors, windows, or screened openings are not considered as permanent openings. **OR**
- Installed with shelter no more inclusive than within a partial enclosure that includes an overhead cover and three sidewalls, as long as 30% or more of the horizontal periphery of the enclosure is permanently open. All openings must be permanently open; sliding doors, garage doors, windows, or screened openings are not considered as permanent openings.
- This appliance is not intended to be installed in or on a boat or recreational vehicle.

Clearance to Combustible Materials

For both, portable, and built-in side burners:

- Maintain a distance of 21" from both sides and back of the side burner to any combustible materials.
- If installed under overhead combustible construction, a suitable UL 710 approved heavy duty vent hood must be installed in conjunction with the side burner.
- The vent hood must be placed in operation while the side burner is being used.

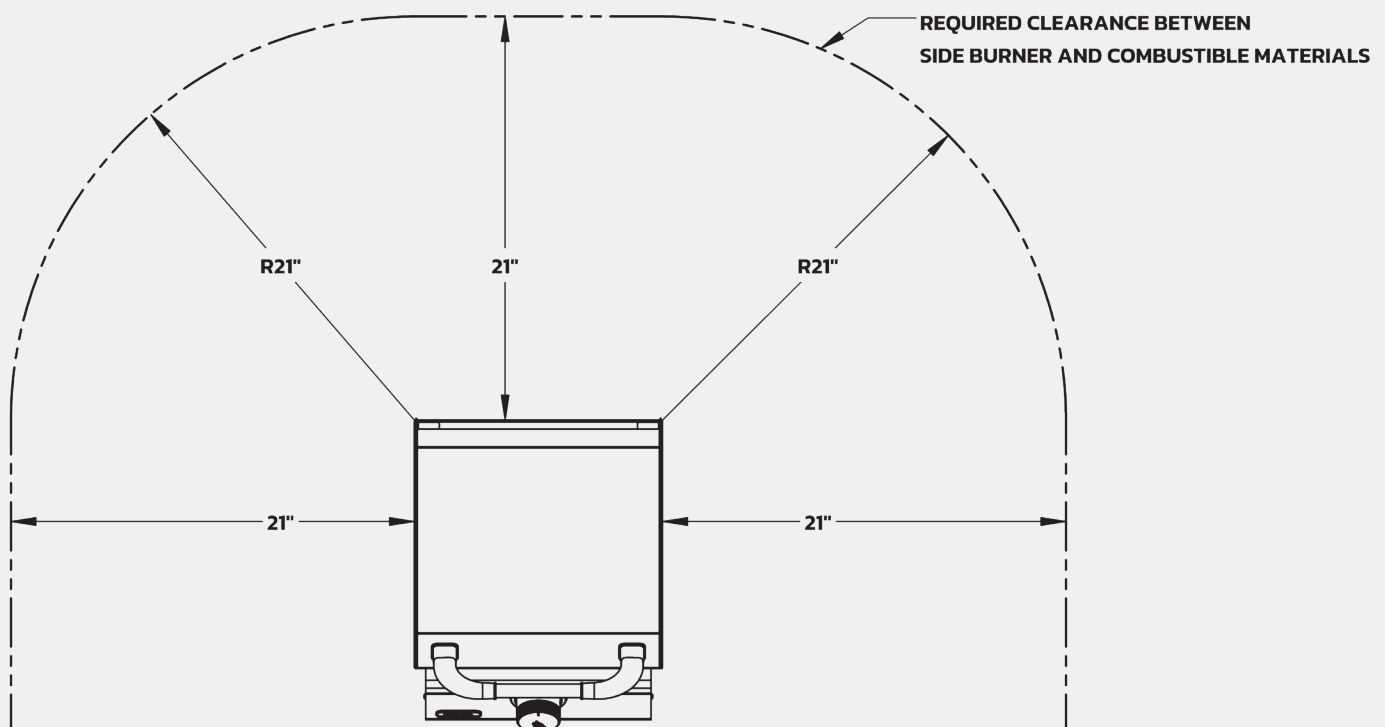

Side burner Enclosure Requirements

When installing the side burner for built-in applications, do not use any combustible materials for the side burner enclosure construction.

LP Cylinder Enclosure Required Provisions:

For LP side burner models (SKU# 60018), additional considerations must be made when constructing the enclosure:

- The side burner enclosure must contain a separate, isolated enclosure for storage of the LP gas cylinder. The storage for the LP gas cylinder must be designed such that only the LP gas cylinder being used can fit in this compartment. It should not be physically possible to store a spare LP gas cylinder vertically, horizontally, or in any orientation within the enclosure when the LP gas cylinder currently in use is installed and properly retained.
- This separate enclosure for the LP gas cylinder shall isolate the cylinder from the burner compartment in order to provide:
 - ◇ Shielding from radiation
 - ◇ A flame barrier
 - ◇ Protection from foreign material, such as hot drippings
- There must be a minimum of 2 inches between the floor of the LP gas cylinder enclosure and the ground.
- The LP gas cylinder must be easily connected and disconnected, and connections shall be able to be tested outside the cylinder enclosure.
- Connections which could be disturbed when installing the cylinder must be accessible for leak testing inside of the enclosure.
- The LP gas cylinder enclosure must include some means of retention as detailed on page 6.

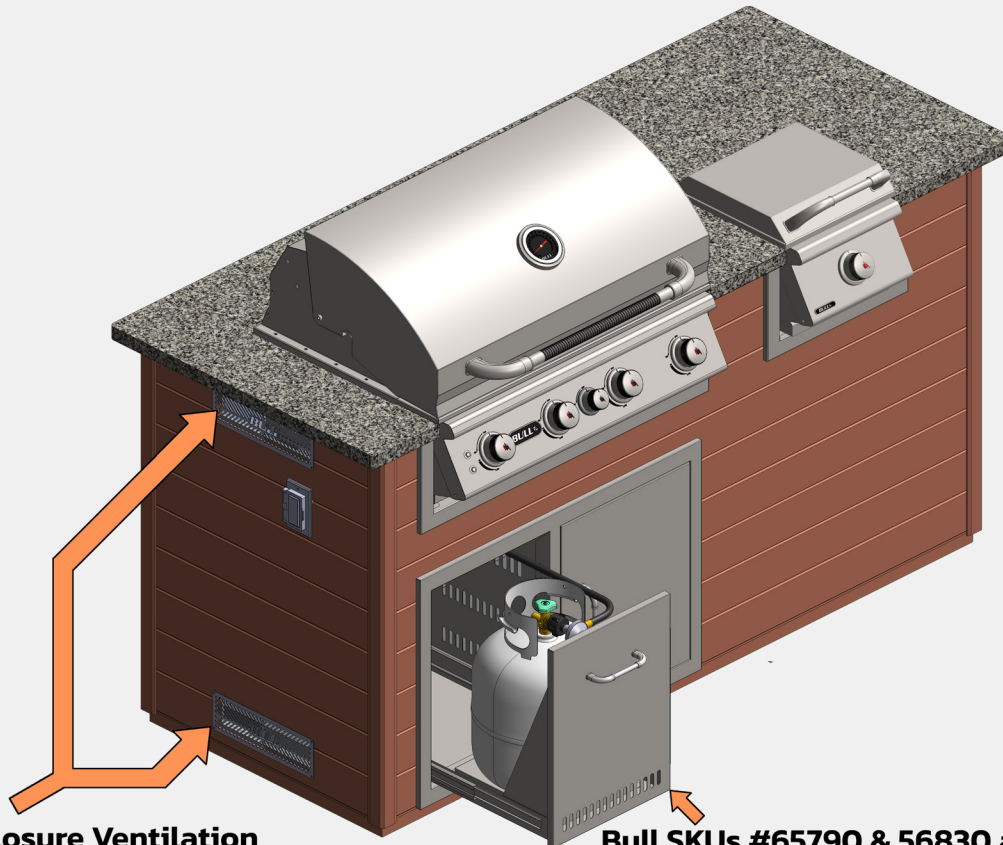

Required Enclosure Ventilation

Bull SKUs #65790 & 56830 are available to help satisfy requirements above

LP Cylinder Enclosure Ventilation:

⚠WARNING: Failure to adequately ventilate your outdoor kitchen could result in an explosion or fire.

The enclosure for the LP gas cylinder shall be properly ventilated. The proper ventilation of the enclosure shall be accomplished by one of the following options:

1. One side of the enclosure shall be completely open.
2. For a cylinder enclosure having four sides, a top, and a bottom, and intended for installation in a built-in enclosure:
 - ◇ At least one ventilation opening shall be provided on the exposed exterior side of the enclosure located within 5 in (127mm) of the top of the enclosure and unobstructed. The opening(s) shall have a total free area of not less than 1 in²/lb (14.2 cm²/kg) of stored fuel capacity (20in² for a 20lb LP gas cylinder).
 - ◇ At least one ventilation opening shall be provided on the exposed, exterior side of the enclosure 1 in (25.4 mm) or less from the floor level and shall have a total free area of not less than 1/2 in²/lb (7.1 cm²/kg) of stored fuel capacity (10in² for a 20lb LP gas cylinder). The upper edge shall be no more than 5 in (127mm) above the floor level.
 - ◇ Every opening shall have a minimum dimension so as to permit the entrance of a 3/16 in (4.8mm) rod.

IMPORTANT: The requirements listed above are the MINIMUM. Bull recommends having ventilation openings on all exposed exterior sides at both top and bottom. The ventilation openings should be sized and located as outlined above.

Side burner Counter top Cutout Dimensions:

Dimensions shown below are in inches and for use with non-combustible constructions only.

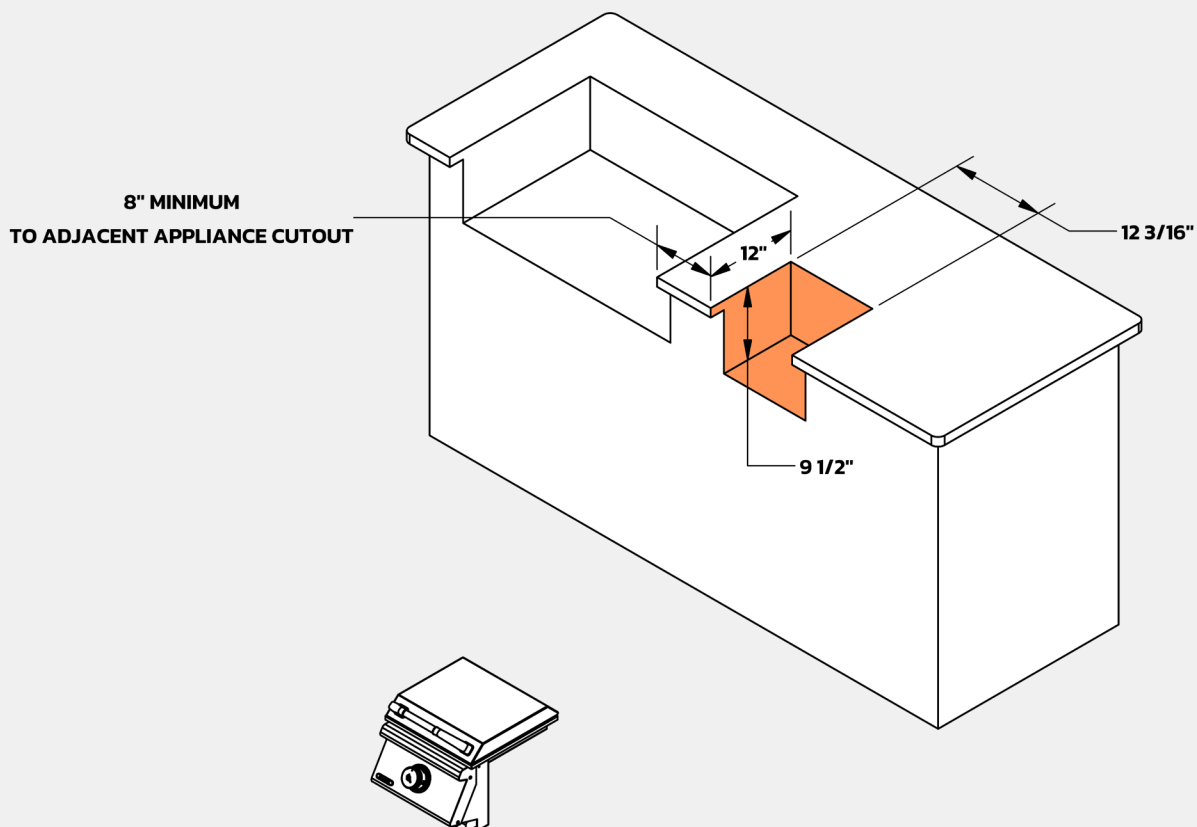

Lighting the Side burner

Prior to lighting your side burner, ensure you have become familiar with the safety guidelines and instructions presented in this manual thus far.

Never attempt to light your side burner if you smell any odor resembling gas. Perform a leak test as prescribed in this document before proceeding.

Side burner Standard Lighting Procedure:

1. Begin by confirming that burner control valve is set to the "OFF" position.
2. Turn the supply gas on.
3. Push in the control knob. Slowly, for roughly 3–4 seconds, rotate the knob counterclockwise by approximately a 1/4 turn. An audible *CLICK* should be heard. By the time the click is heard, the burner should have provided enough gas to ignite and a visible flame should be present. **If the burner does not ignite, immediately return the control knob to the "OFF" position; wait five minutes for any gas to disperse and repeat this process.**
4. Adjust the control knob to the desired cooking temperature.



Side burner Manual Lighting Procedure:

If the ignitor fails to produce a spark at the electrode tip, the burner can be manually ignited using a long-necked lighter.

1. Begin by confirming that burner control valve is set to the "OFF" position.
2. Turn the supply gas on.
3. Use long-necked lighter, placing the flame near to the burner ports.
4. Push in the control knob. Slowly, for roughly 3–4 seconds, rotate the knob counterclockwise by approximately 1/4 turn. An audible *CLICK* should be heard. By the time the click is heard, the burner should have provided enough gas to ignite. If the burner does not ignite, immediately return the control knob to the "OFF" position; wait five minutes for any gas to disperse and repeat this process.
5. Adjust the control knob(s) to the desired cooking temperature.



Burner Flames

The burner on your side burner is preset by the factory for best performance. However, many factors such as variations in your gas supply, or dirty/clogged orifice may cause your burner to not operate as intended.

- Flames should be blue and stable. Any yellow flame (excluding at the very tips) indicates insufficient air supply.
- Flames should be quiet. A noisy, lifting flame indicates excessive air supply.
- Flame heights should be approximately:
 - ◇ 1/4" on "LOW"
 - ◇ 1-3/4" on "HIGH"

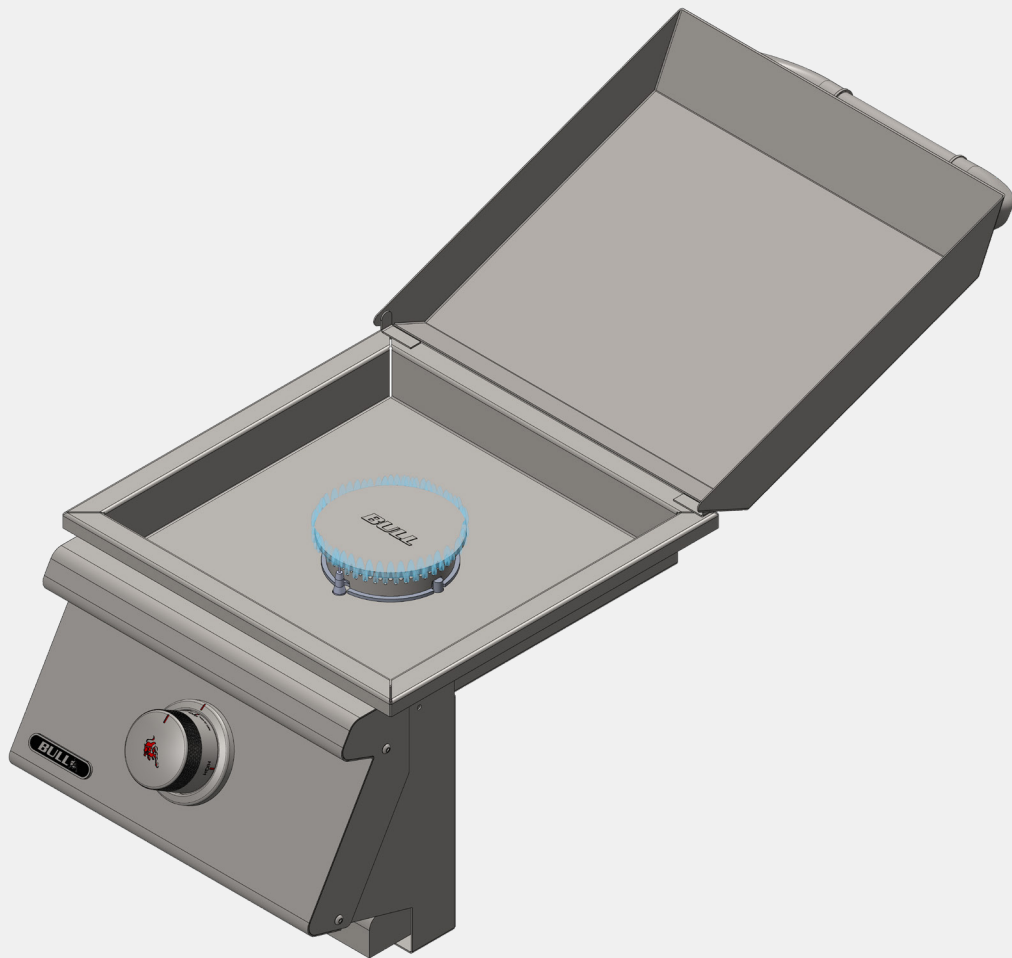

Burner Maintenance

Proper maintenance of your appliance's burner will not only keep your burners in pristine shape, but also reduces the risk of flashbacks as described on page 4.

At least once a month, or when your side burner has not been used for a prolonged period of time, it is imperative to inspect and clean your burner. To properly inspect and clean your burner, it should first be removed from the side burner.

The burner simply rests in the burner base, and no tools are required for removal. Simply lift the two-piece burner out from the side burner body,

With the burner removed:

- Begin by inspecting the burner base and all outlet ports, and verify they are damage free and clear of debris.
- Check for any signs of corrosion, cracks, or holes. If any such damage is identified, order and install a new burner before returning to service.
- Clean the burner as detailed below.
- Once inspected and cleaned, re-install the burner in reverse order of disassembly.

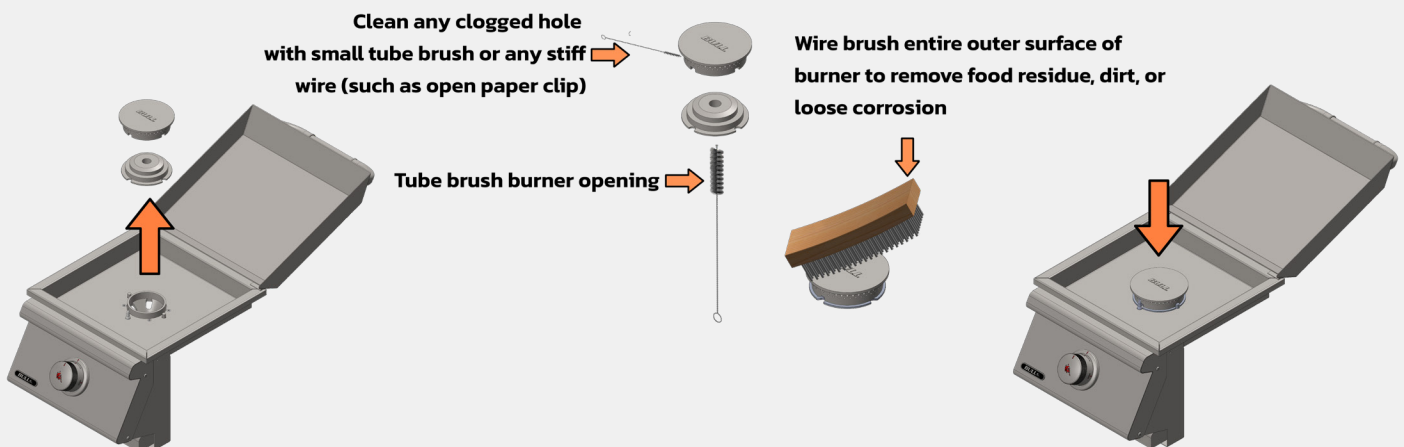

- Verify that the burner top is properly located with respect to the base as shown below.

WARNING: If the burner top does not fit inside the base, lighting the burners may cause an explosion and/or fire

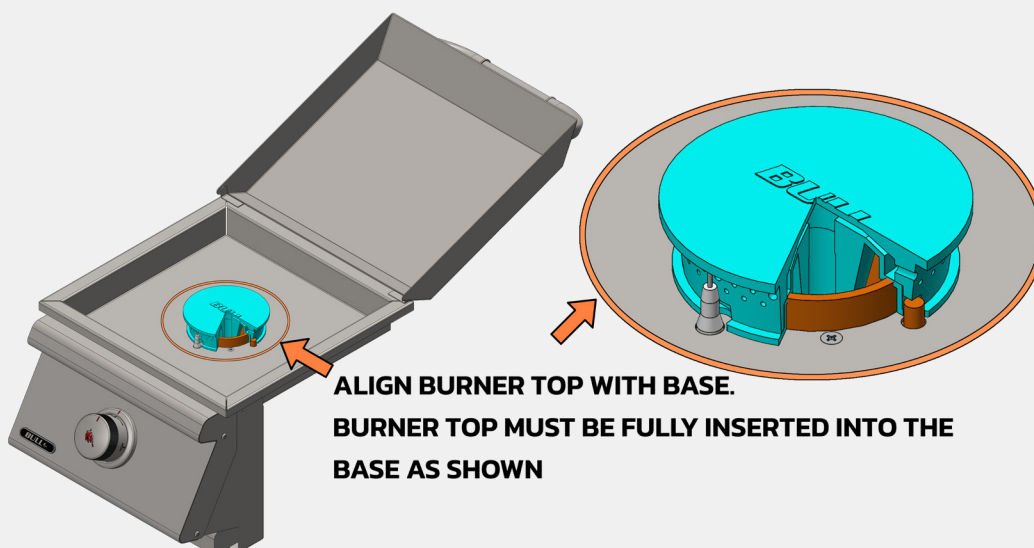

Ignition System Inspection:

After re-installation of the burners is a good time to perform an inspection on your side burner's ignitor. This is accomplished with the following procedure:

1. Ensure the supply gas to the side burner is turned off.
2. Ensure control knob on the side burner is set to the "OFF" position.
3. Push in control knob and slowly turn approximately 1/4 turn counterclockwise until an audible *CLICK* is heard. Prior to the click, look near the burner's ignitor probe and be on the lookout for a blue spark at the electrode tip.
4. Once the click is heard, determine if a blue spark was present. If not refer to page 17 for troubleshooting.

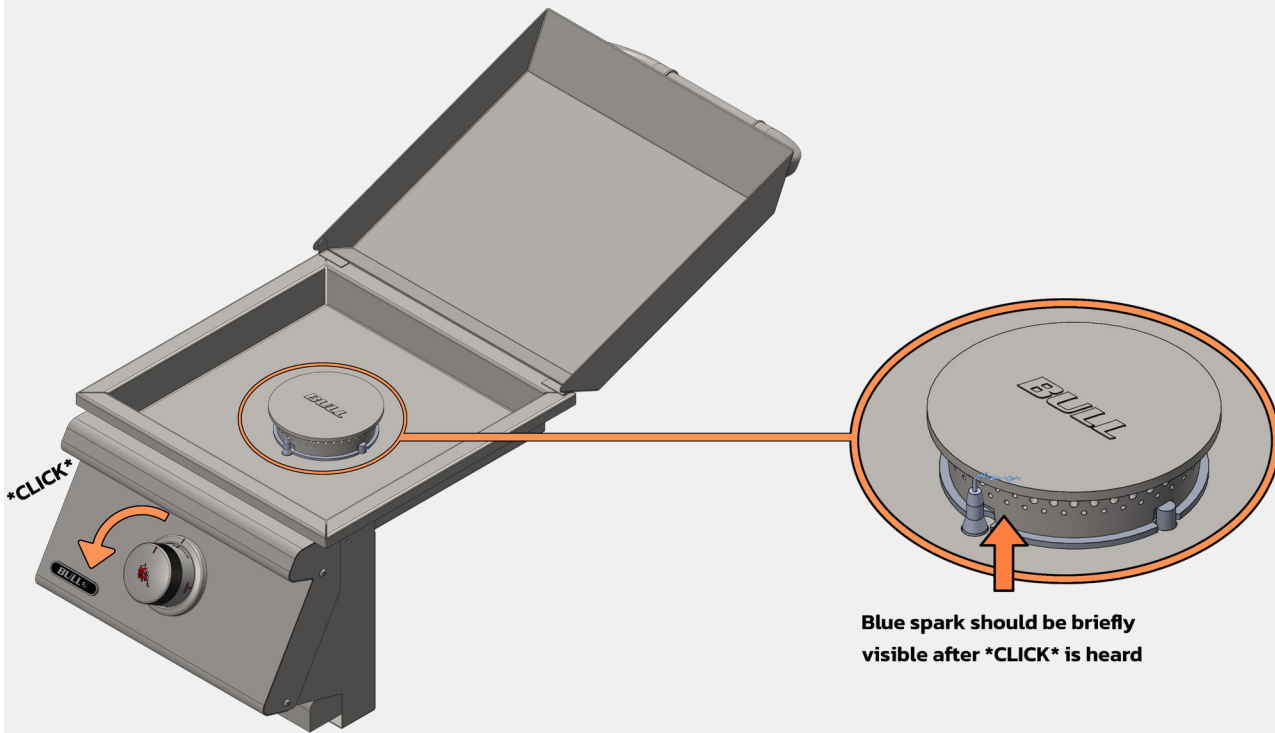

Cleaning the Side burner

Your Side burner's outstanding luster and durability is attributed to Stainless Steel construction. Stainless Steel has an outer layer that relies on a proper cleaning and maintenance routine as the best way to prevent corrosion. Please note, Stainless Steel is not 'rust proof' contrary to widespread belief. Side burners are at higher risk of corrosion by exposure to chemicals, caustics and fertilizers from swimming pools and outdoor landscaping. Locations with climates with greater heat and humidity will intensify this condition. By following a proper cleaning routine, you will add to the years you enjoy your Bull side burner.

Cooking Grates:

After cooking, turn control knob to "OFF" and let side burner cool before attempting to clean your cooking grids. Before first use and periodically it is suggested that you wash the cooking grids in a mild soap and warm water solution. You can use a washcloth or a vegetable brush to clean your cooking grids.

Side burner Housing:

Burning-off the side burner after every cookout will keep it ready for instant use. However, periodically the side burner should be cleaned thoroughly to ensure optimal performance. Bull recommends doing the following on an annual basis:

1. Shut off gas supply at source and disconnect fuel line from gas valve manifold. Protect fuel line fitting.
2. Remove and clean the cooking grates and burners.
3. Cover the venturi tube opening with a piece of aluminum foil.
4. Brush the inside and bottom of the side burner with a stiff wire brush and wash down with a mild soap and warm water solution. Rinse thoroughly and let dry.

Troubleshooting

If your side burner is not functioning properly, use this troubleshooting table below to diagnose and address your issue. If you are unable to remedy your problem, consult your side burner dealer or gas appliance service person.

Issue	What to do
Side burner Fails to Light	<ul style="list-style-type: none"> • Turn off gas at supply-end, turn control knob to the "OFF" position. • Check gas supply and all connections. • Wait five minutes. • Repeat standard lighting procedure on Page 12. • If issue still persists, check for potential causes below.
Obstruction in Gas Line	<ul style="list-style-type: none"> • Disconnect fuel line from side burner. • Open gas supply briefly to dislodge any obstructions from the fuel line. • Close off the supply line at the source and reconnect the supply to the side burner.
Misaligned Ignitor	<ul style="list-style-type: none"> • Check the position of the electrode tip on ignitor. The tip of the electrode should be free from grease where the spark discharges. • The ignition wire should be rigidly connected to the valve ignition and electrode. • Replace the ignition wire if broken or cracked. • Verify ignitor is working properly by following procedure outlined on Page 15.
Burner Flame is Yellow	<ul style="list-style-type: none"> • The burner may have seasoning salts, oil film, or other foreign matter causing the discolored flame. Clean the burner with a wire brush and see if problem persists.
Flashback	<ul style="list-style-type: none"> • When a fire occurs in or around the burners, immediately turn off the gas supply. • Turn control knob to the "OFF" position. • Wait until the side burner has cooled completely. • Remove the affected burner following instructions on Page 14. • Clean the burner as shown on Page 14.

IMPORTANT: During troubleshooting you may find re-ignition necessary. Do not re-light the side burner while it is still hot. You must wait at least five minutes to allow accumulated gas to disperse.

Product Warranty and Registration

Thank you for choosing Bull Outdoor Products. To enable our commitment to your satisfaction, you will need to register your purchase for it to be covered under Bull's warranty policy. Please save your purchase receipt as it is required for warranty claims. Additionally, registering your purchase will allow Bull or your Bull Authorized Dealer to utilize the encoded information for the purpose of ordering replacement parts or additional accessories to ensure your purchase remains in optimal working condition. To validate your warranty, we offer two options as shown below:

Option 1: Online Registration

 Registration can be completed on the Bull Customer Service Portal

 Scan the QR code, or visit: <https://api.bullbbq.com/c/>

Option 2: Mail-in Registration

Complete the Product Warranty Registration Card located in the shipping box. A reference of the card is shown to the right.

Mail the completed card to:

BULL OUTDOOR PRODUCTS, INC.
15 East Ave, Athens, TN
Attn: Warranty Service Center



Bull Outdoor Products Warranty Registration Card **BULL**

Name _____ Date of Purchase _____

Place of Purchase _____ Phone _____

Email Address _____ Apt # _____

Street Address _____

City _____ State _____ Zip Code _____

How To Register
On Our Website: Bullbbq.ladesk.com/submit_ticket
Via Mail: Fill out this form and mail it to us!

Model Name: _____

Model Number: _____

Serial Number: _____

Scan This Code With Your Phone 

Unpacking the Side burner:

After opening the box, carefully inspect the contents for any damage. Contact our service center or local dealer for replacement of any damaged/missing parts. If damaged, do not attempt to install.

Ordering Replacement Parts:

Please refer to your owner's manual parts list and illustration(s) to identify what you need. Have your serial number ready. Replacement parts can be purchased via two options.

Option 1: Online

 Scan the QR code, or visit:
<https://bullbbq.com/buy-parts>



Option 2: Phone

We have two authorized parts distributors ready to assist.

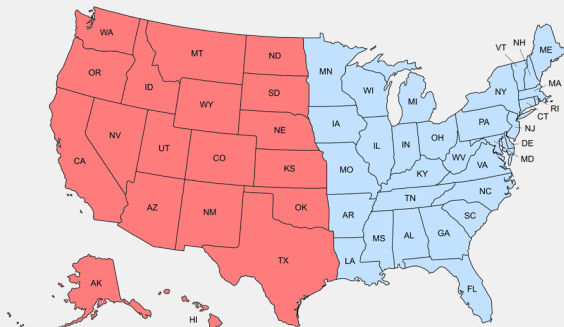

Western Region
(800) 258-6810

Eastern Region
(800) 229-3056

Serial Number Locations:

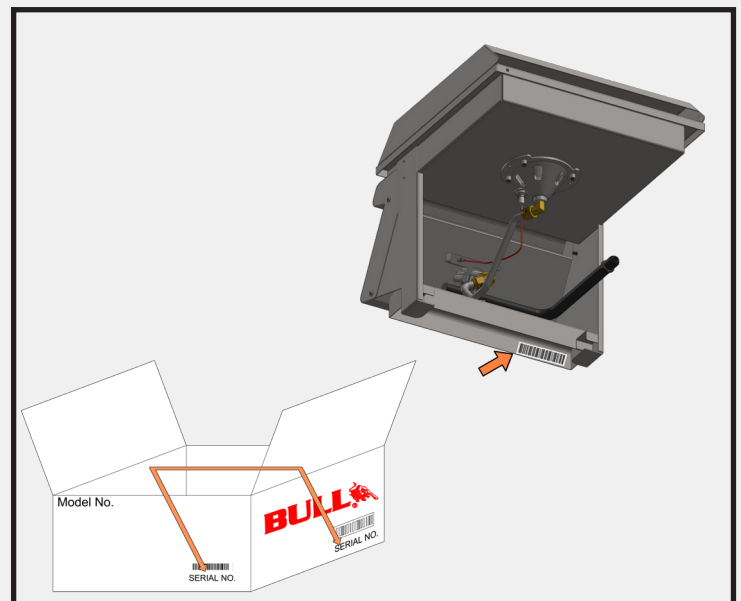

Warranty Policy

LIMITED WARRANTY ON BULL OUTDOOR PRODUCTS, INC., PRODUCTS

THIS LIMITED WARRANTY GIVES YOU SPECIFIC LEGAL RIGHTS. YOU MAY ALSO HAVE OTHER RIGHTS, WHICH VARY FROM STATE TO STATE.

THIS LIMITED WARRANTY CAN ALSO BE FOUND ON OUR WEBSITE AT:

<https://www.bullbbq.com/support-warranty> (United States Customers)

<https://www.bullbbq.eu/customer-care/#warranty-registration-form> (International Customers)

AND IN THE OWNER'S/INSTALLATION MANUALS THAT WE PROVIDE WITH OUR PRODUCT

THIS LIMITED WARRANTY IS SUBJECT TO THE EXCLUSIONS, CONDITIONS AND LIMITATIONS SET FORTH BELOW.

ANY IMPLIED WARRANTIES IMPOSED BY LAW, INCLUDING WITHOUT LIMITATION TO THE IMPLIED WARRANTIES OF MERCHANTABILITY AND FITNESS FOR A PARTICULAR PURPOSE, ARE LIMITED IN DURATION TO THE DURATION OF THIS EXPRESSED LIMITED WARRANTY. SOME STATES DO NOT ALLOW LIMITATIONS ON HOW LONG AN IMPLIED WARRANTY LASTS, SO THE ABOVE LIMITATION MAY NOT APPLY TO YOU.

WHO MAY USE THIS WARRANTY?

BULL OUTDOOR PRODUCTS, INC. located at address 15 East Ave. Athens, TN 37303

("We") extend this limited warranty only to the consumer who originally purchased the product ("you") at the original site of delivery or installation. It does not extend to any subsequent owner or other transferee of the product. It does not extend to any rental, commercial, or non-residential application. Examples of excluded applications include, but are not limited to day care centers, schools, bed and breakfast centers, churches, private clubs, fire stations, club houses, Common areas in multi-family dwellings, restaurants, hotels, nursing homes, food service locations, and institutional food service locations.

WHAT DOES THIS WARRANTY COVER?

This limited warranty covers defects in materials and workmanship of the product and product components identified below for the Warranty Periods defined below.

WHAT IS THE PERIOD OF COVERAGE?

This limited warranty starts on the date of your purchase and lasts for the time periods specified on the next page. The Warranty Period is not extended if we replace the product. We may change the availability of this warranty at our discretion, but any changes will not be retroactive.

Warranty Policy (Continued)

Grilling/Pizza Accessories and Grill Covers DO NOT include a warranty period

Grill Warranty Periods

The following parts are covered for **1 year** on all our current gas grill models:

- The lid, control panel, grease tray, bezels, knobs, temperature gauge, valves, regulator, flex tubes, rotisserie burner, transformer, and all components of the lighting system.

The following parts are covered for **3 years** on all our current gas grill models:

- The manifold, handle end caps, flame tamers, heat shields, and warming rack.

The following parts are covered for the **Lifetime** on all our current gas grill models:

- Insert assembly and the grates.

The warranty period for the grill burners varies by type:

- Cast stainless steel burners – **Lifetime**
- Welded stainless steel burners – **5 years**
- Porcelain coated burners – **3 years**

The warranty period for the charcoal grill is **1 year** on all parts, except for the insert assembly, which is covered for **5 years**.

Component Warranty Periods

All the parts for our components /grill carts/refrigerators/kegerators/drawers/doors/refrigerator frames/grill

jackets/finishing frames/ice chest/sinks/bar center and vent hoods are covered for **1 year** with these exceptions:

• Power Burner

- o The insert/grates are **lifetime** covered parts.
- o The manifold/burner are covered for **3 years**.

• Searing Station/Slide in Double Sideburner

- o The grates are covered for **lifetime**,
- o The insert for **5 years**, and
- o The manifold for **3 years**.

• Single Sideburner

- o The grates are covered for **5 years** and
- o The burner for **3 years**.

• Sidekick

- o The burner is covered for **3 years**.

• Heaters

- o The heater replacement parts are covered for **3 years**.

• Pizza Ovens/Islands/Fire Features Warranty Periods

- o All of the parts and construction materials are covered for **1 year**.

Warranty Policy (Continued)

WHAT DOES THIS WARRANTY NOT COVER?

This limited warranty does not cover any damage due to:

- Transportation.
- Storage
- Improper installation or use.
- Use on improper fuel/gas supply.
- Failure to follow the product instructions or to perform any preventive maintenance.
- Modifications.
- Normal wear and tear, rust, corrosion, oxidation, or discoloration.
- External causes such as accidents, abuse, or other actions or events beyond our reasonable control.

WHAT OPTIONS ARE OFFERED BY BULL OUTDOOR PRODUCTS UNDER THIS WARRANTY?

With respect to any defective product claim made during the Warranty Period, we will, in our sole discretion:

- Replace such product (or the defective part) free of charge.

WHAT IS EXCLUDED BY BULL OUTDOOR PRODUCTS UNDER THIS WARRANTY?

- We will not pay for shipping charges for replacement parts, or for any labor or labor related charges.
- We will not pay for any accessory products or ancillary products purchased by you for use in connection with the product.

HOW DO YOU NOTIFY BULL CUSTOMER SERVICE OF A POTENTIAL WARRANTY ISSUE?

Our Customer Service is ready to help. Here's how to reach us:



By Phone (800) 521-2855 Monday through Friday from 8:00 a.m. to 5:00 p.m. (EDT)



To submit a warranty, claim on-line or message go to <https://www.bullbbq.com/support-warranty.com>

LIMITATION OF LIABILITY

THE REMEDIES DESCRIBED ABOVE ARE YOUR SOLE AND EXCLUSIVE REMEDIES AND OUR ENTIRE LIABILITY FOR ANY BREACH OF THIS LIMITED WARRANTY. OUR LIABILITY SHALL UNDER NO CIRCUMSTANCES EXCEED THE ACTUAL AMOUNT PAID BY YOU FOR THE DEFECTIVE PRODUCT, NOR SHALL WE UNDER ANY CIRCUMSTANCES BE LIABLE FOR ANY CONSEQUENTIAL, INCIDENTAL, SPECIAL OR PUNITIVE DAMAGES OR LOSSES, WHETHER DIRECT OR INDIRECT.

SOME STATES DO NOT ALLOW THE EXCLUSION OR LIMITATION OF INCIDENTAL OR CONSEQUENTIAL DAMAGES, SO THE ABOVE LIMITATION OR EXCLUSION MAY NOT APPLY TO YOU.

v2025.02.14